

PLAN D'IMPLANTATION ODYSSEE21WQP-CP

VUE DE FACE

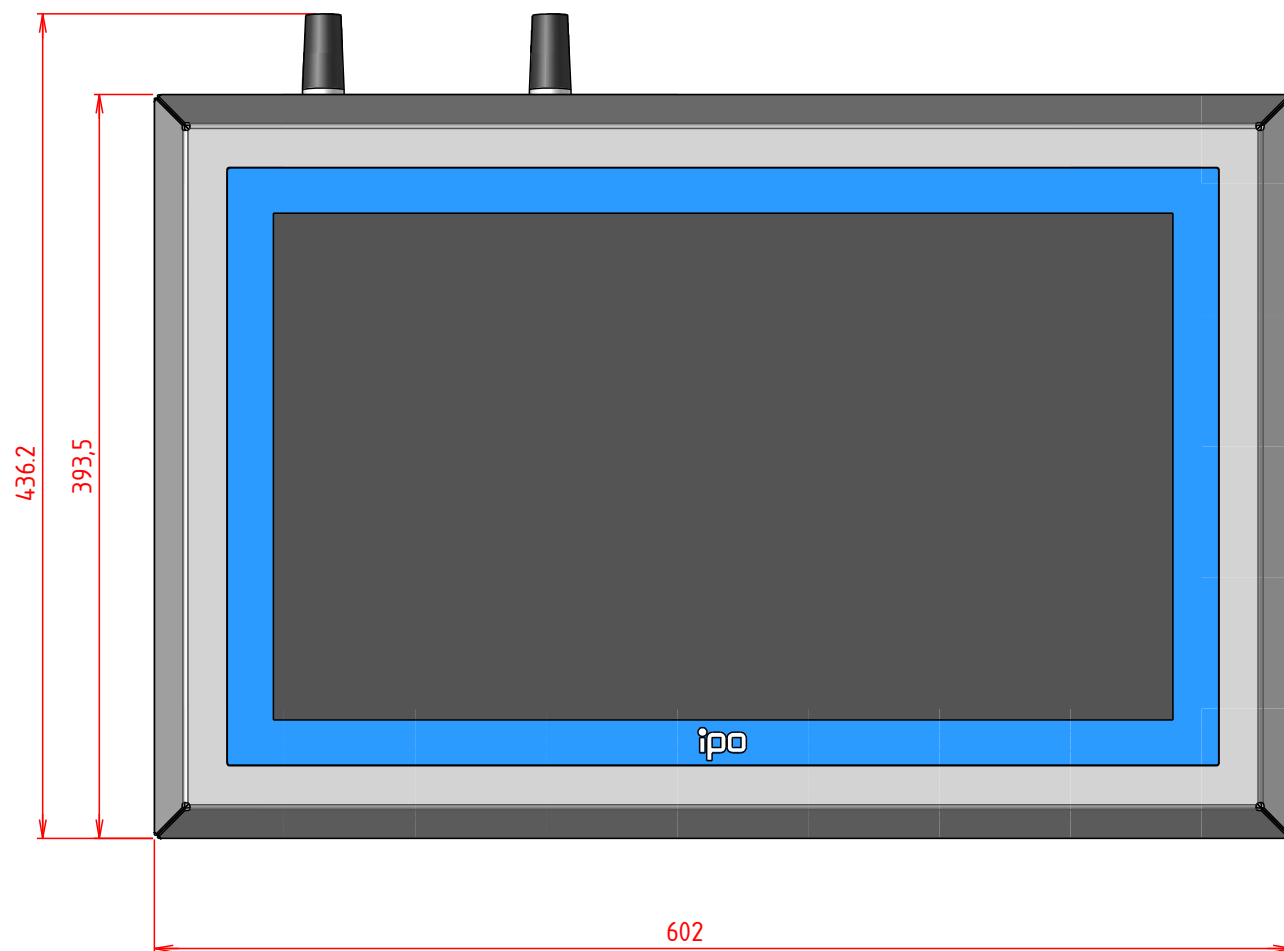

VUE ARRIERE

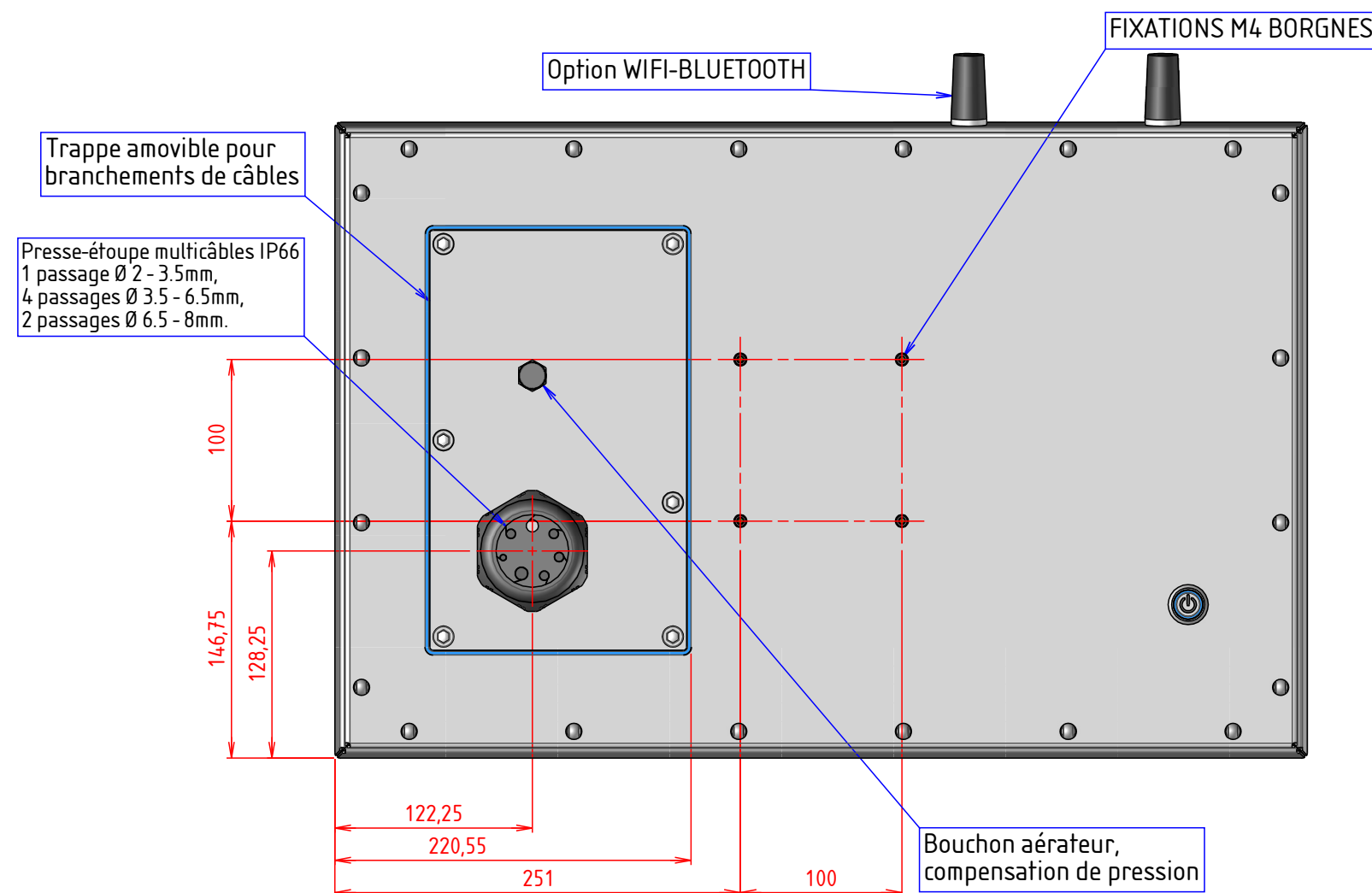

VUE DE DESSUS

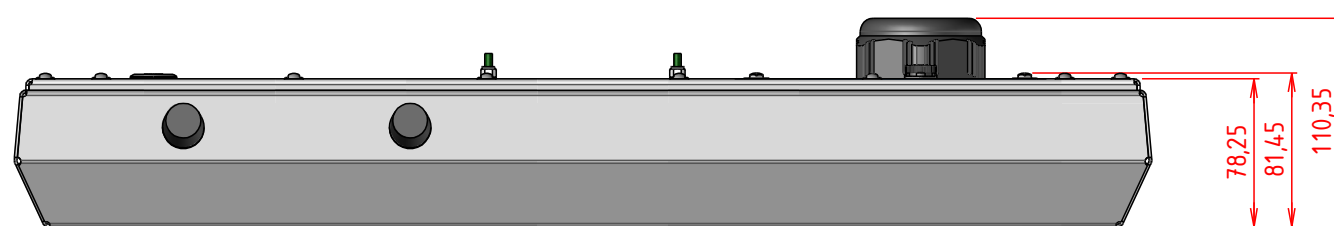

PERSPECTIVE

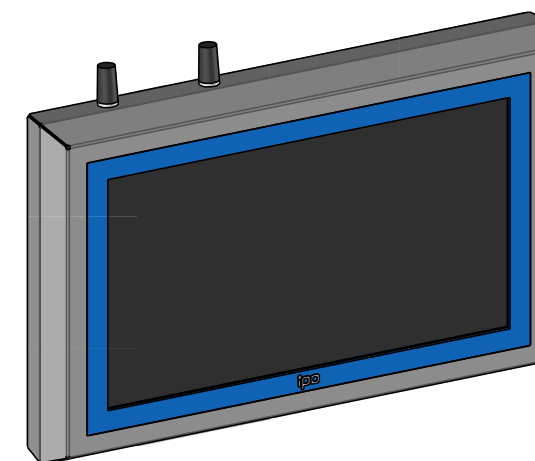

D

A