

ITAS 18W

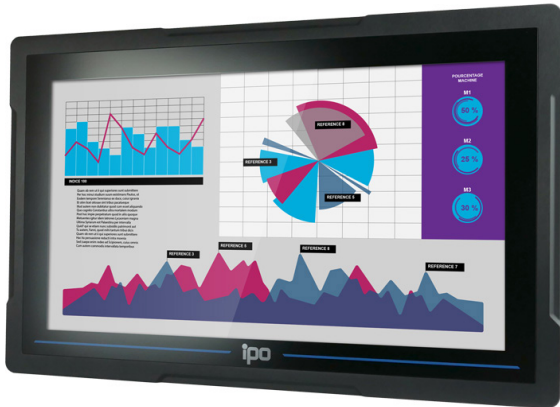

Moniteur industriel encastrable

- ▶ Solution sans ventilation (Fanless)
- ▶ Face avant True-flat
- ▶ Écran LCD TFT 18.5" Wide LED
- ▶ Résolution Full HD 1920 x 1080
- ▶ Compatible : VGA / HDMI / Display port
- ▶ Dalle tactile Multitouch PCAP (6H)
- ▶ Étanche IP65 face avant
- ▶ Protection aux chocs IK08
- ▶ Alimentation industrielle interne AC ou DC large plage
- ▶ Garantie standard 2 ans

Les + :

- ▶ Encastrement facile
- ▶ Face avant True-flat
- ▶ Étanche IP65 face avant

Plan d'implantation

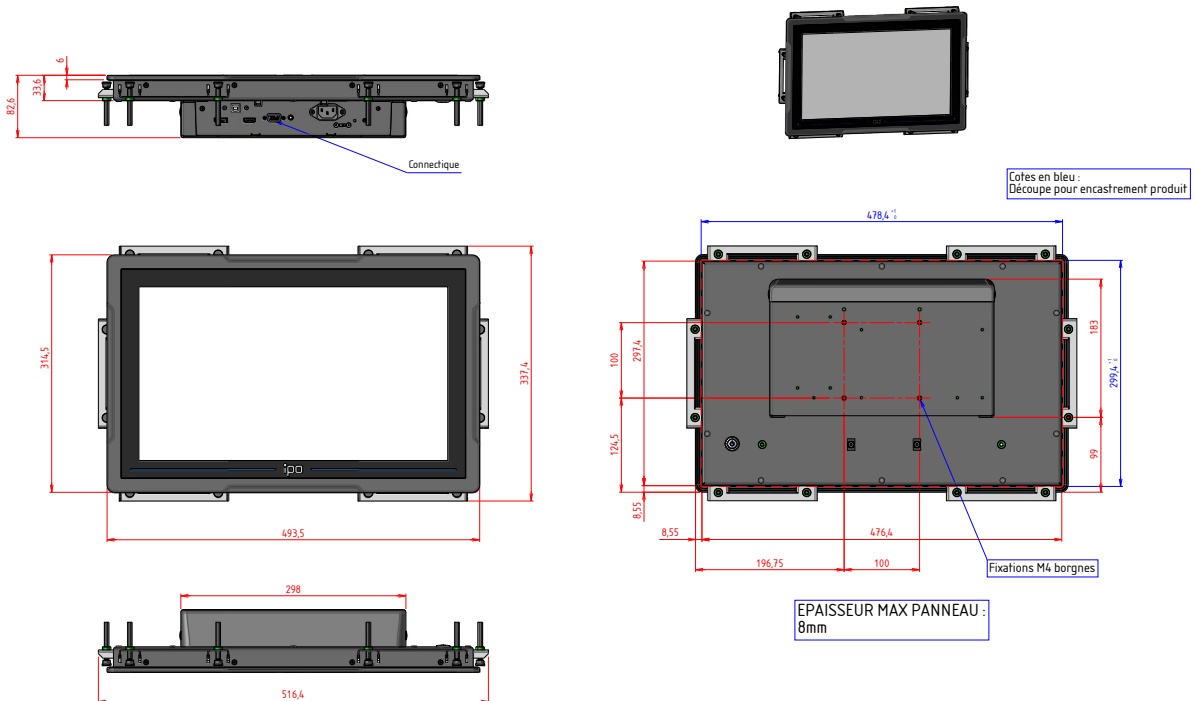











Référence de commande

ITAS18W-CV-**

Moniteur Fanless industriel - Encastrable - Face avant Trueflat - IP65 face avant - 18.5" Full HD - Connectique entrée : VGA/HDMI/DP - Dalle tactile PCAP (6H) - Préciser l'alimentation choisie

** : Préciser l'alimentation choisie : **AC** Interne 230VAC ou **DC** 9-36VDC

Produit garantie standard 2 ans pièces et main-d'œuvre retour atelier

 <p>Châssis</p> <p>Coffret Face avant Couleur châssis Solution de fixation Dalle tactile Audio</p>	<p>2 mm d'épaisseur - Aluminium peint 6 mm d'épaisseur - Aluminium anodisé Joint d'étanchéité Noir RAL9005 Encastrable avec Taquets de fixation (x6) Empreinte VESA 100 3 mm d'épaisseur Haut-Parleur 1 x 3W</p>	 <p>Affichage / Ecran</p> <p>Taille de l'écran / Diagonale Surface d'affichage Résolution native Prise en charge des couleurs Pas de masque (pixel) Luminosité Contraste Angle maximum de vision</p>	<p>18.5" Wide - Technologie Backlight LED 408.96 x 230.04 mm 1920 x 1080 Full HD 16.7 millions 0.213 mm 400 cd/m² 1500:1 Horizontal : 170° - Vertical : 170°</p>
 <p>Protection</p>	<p>IP65 face avant - Zone d'affichage IK08 - Zone d'affichage</p>	 <p>Dalle tactile</p>	<p>Dalle tactile PCAP verre (6H) Trueflat multitouch 10 points</p>
 <p>Connectique</p>	<p>VGA HDMI Display Port Dalle tactile 1 x Empreinte antivol</p>	 <p>Alimentation Industrielle</p> <p>Version AC~ Version DC Puissance consommée</p>	<p>Entrée : 115/230VAC - Fréquence : 50/60Hz Entrée large plage: 9-36VDC Protection inversion polarité Isolation galvanique 25W</p>
 <p>Commande / voyant</p>	<p>Interrupteur rétroéclairé marche-arrêt Voyant «Non Signal» Menu écran + réglage de luminosité</p>	 <p>Normes & Certifications</p>	<p>Sécurité EMC</p> <p>EN 62368-1 EN 55032 / EN 55024 EN 61000-3-2 / EN 61000-3-3</p>
 <p>Environnement</p>	<p>Temp. de fonctionnement Température de stockage Humidité sans condensation</p>	 <p>Normes & Certifications</p>	<p>Dimensions en mm (LxHxP) Poids net en kg</p> <p>493.5 x 314.5 x 82.6 7.5</p>
 <p>Ventilation</p>	<p>Fanless (Sans ventilation) Refroidissement par convection naturelle</p>		

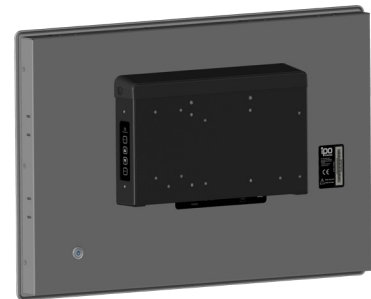

Connectique

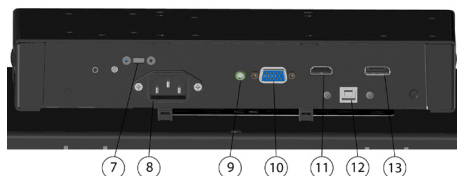
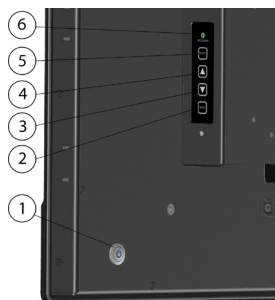

- | | | | |
|---|---------------------------------------|----|-----------------------|
| 1 | Bouton marche arrêt + bouton power | 8 | Alimentation secteur |
| 2 | Menu écran | 9 | Entrée audio |
| 3 | Lumière - / Bouton « bas » dans menu | 10 | VGA |
| 4 | Lumière + / Bouton « haut » dans menu | 11 | HDMI 1.3a |
| 5 | Select | 12 | Dalle tactile par USB |
| 6 | Voyant no signal | 13 | Display port |
| 7 | Keylock / antivol | | |

Liste de colisage

- | | | | |
|---|------------------------|---------------------------------------|------------------|
| 1 x Câble secteur CE22 1.80 m (Version AC~) | 1 x Câble USB 1.80 m | 1 x Câble HDMI 2 m | 1 x Câble DP 2 m |
| 1 x Câble VGA 2 m | 6 x Taquets de blocage | 1 x Fiche de Production & Tracabilité | |